

Multiline Seal in V100E 0.0
Modul: 0.0

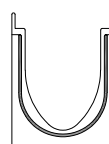

Multiline Seal in V100E 5.0
Modul: 5.0

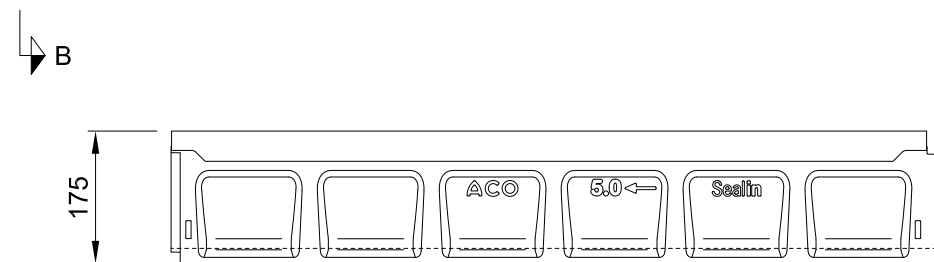
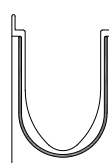
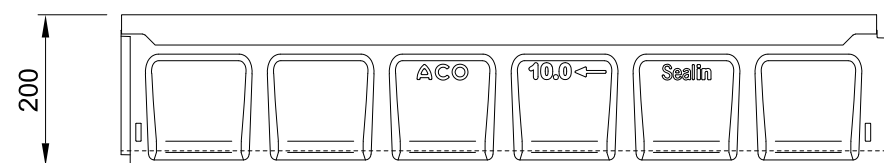

Multiline Seal in V100E 10.0
Modul: 10.0

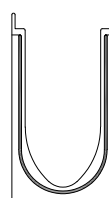
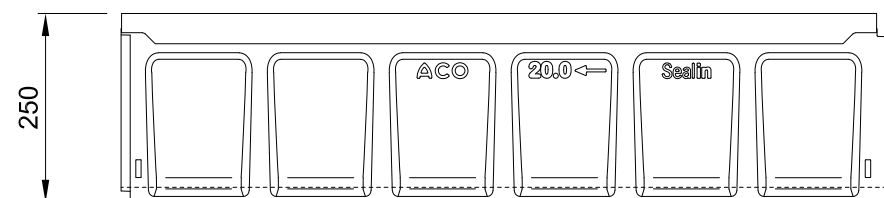

Multiline Seal in V100E 20.0
Modul: 20.0

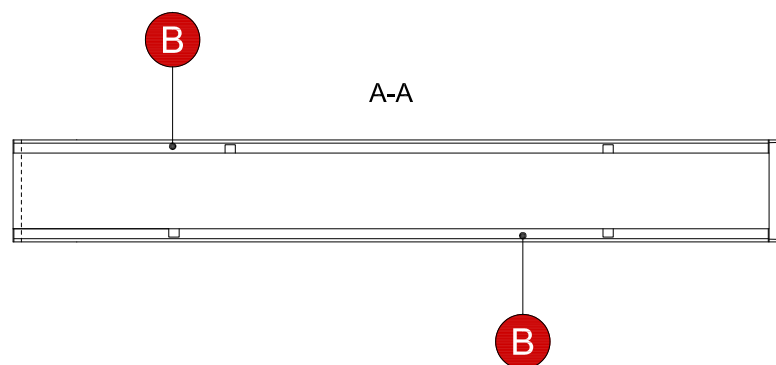

- Förklaringar**
Alla mått i millimeter
Dimensioner avrundade till närmsta hela mm om ej annat anges
- A Integrerad gummitätning
 - B Integrerad kantförstärkning
 - C V-format tvärsnitt
- 888* Dimension avrundad till närmsta hela 5 mm

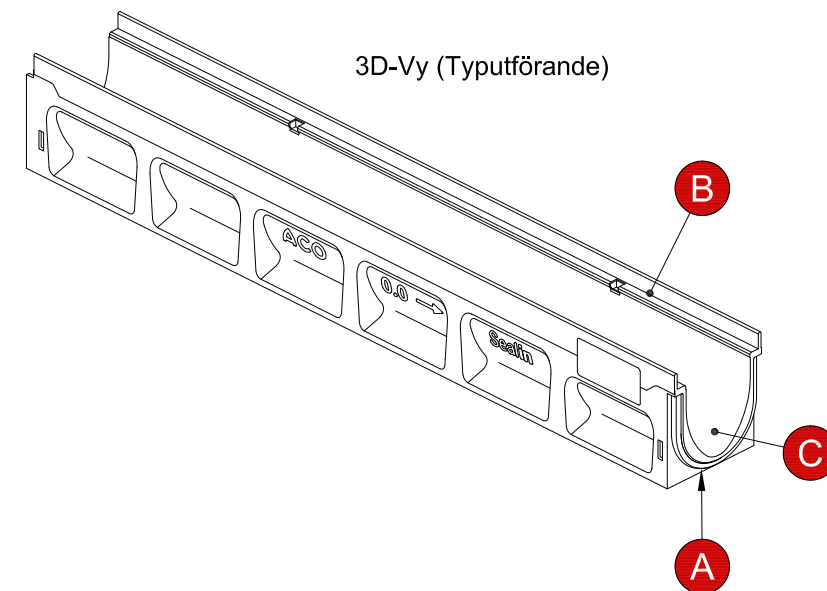

Egenskaper

Material	Polymerbetong
Rännbredd	100 mm
Kantförstärkning	Rostfritt stål
Belastningsklass	A15 - E600

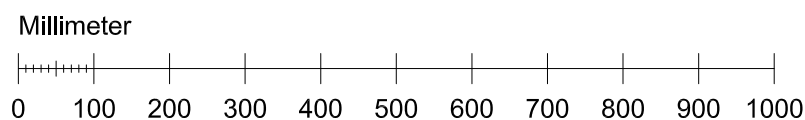

ACO Nordic AB
Industrivägen 4
433 61 Sävedalen
www.aco-nordic.se

Produkt
Multiline Seal in V100E
Ränna utan fall - 1000 mm

Skala
1:10 (A3)

Ritning
2D