

Multiline Seal in V100S 0.0
 Modul: 0.0
 (RSK-nummer: 291 92 77)

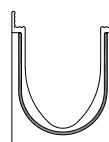

Multiline Seal in V100S 5.0
 Modul: 5.0
 (RSK-nummer: 291 92 78)

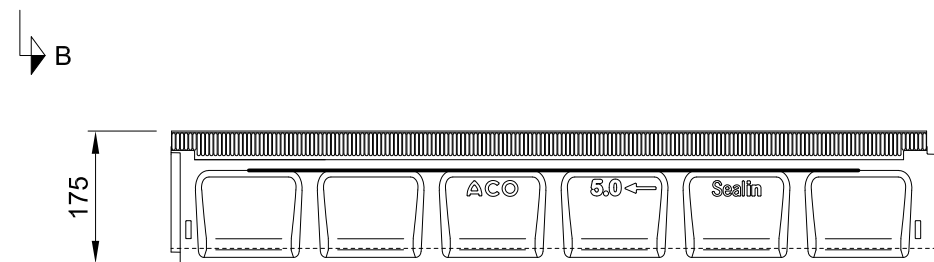
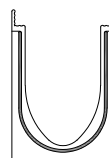
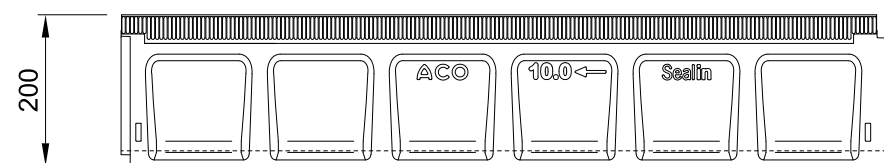

Multiline Seal in V100S 10.0
 Modul: 10.0
 (RSK-nummer: 291 92 79)

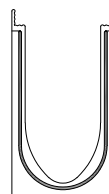
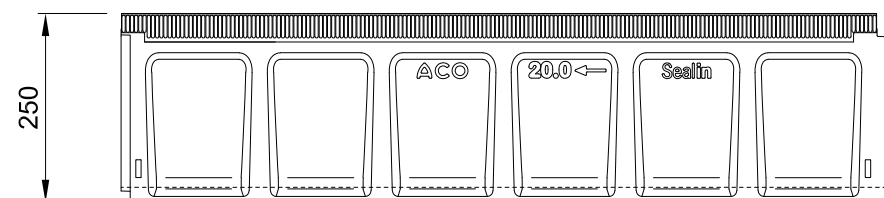

Multiline Seal in V100S 20.0
 Modul: 20.0
 (RSK-nummer: 291 92 80)

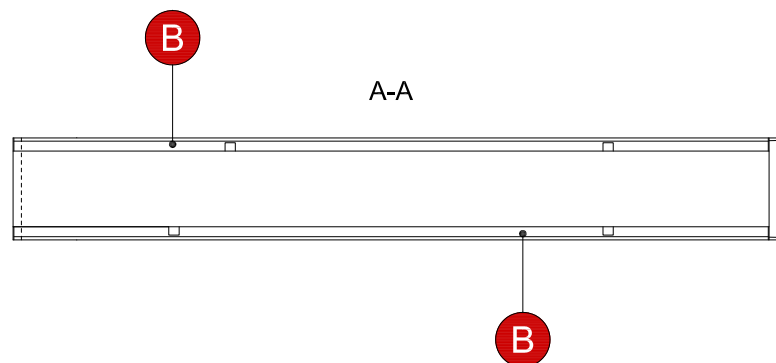

Förklaringar

Alla mått i millimeter
 Dimensioner avrundade till närmsta hela mm
 om ej annat anges

- A Integrerad gummitätning
- B Integrerad kantförstärkning
- C V-format tvärsnitt

888* Dimension avrundad till närmsta hela 5 mm

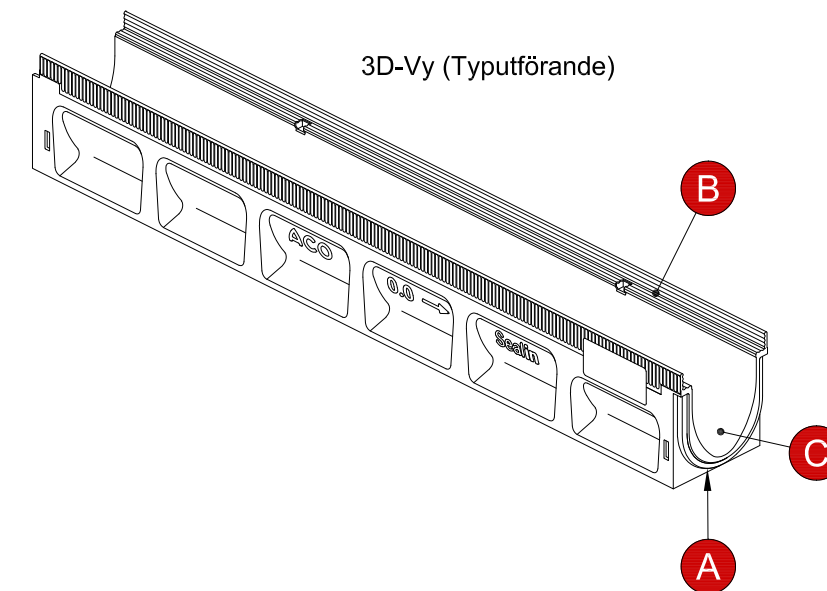

Egenskaper

Material	Polymerbetong
Rännbredd	100 mm
Kantförstärkning	Varmförzinkat stål
Belastningsklass	A15 - E600



ACO Nordic AB
 Industrivägen 4
 433 61 Sävedalen
 www.aco-nordic.se

Produkt
Multiline Seal in V100S
 Ränna utan fall - 1000 mm

Skala
 1:10 (A3)

Ritning
 2D

